

GUIDE SHEAVE
VERTICAL

MD-1118

STANDARD FEATURES

- Designed for Breaking Strength of 1-1/2" (38 mm) EIPS Wire Rope, 228,000 LBS, with 90° Wrap on the Sheave
- Cast Steel Sheave with Hardened Rope Groove for Longer Life
- Sealed Grease Lubricated Tapered Roller Bearings in Sheave
- Weld Down Mounting Base
- Epoxy Primer Coating

OPTIONAL FEATURES

- Customized Design to Suit Your Application
- Multiple Sheaves
- Stainless Steel or Nylon Sheaves
- Bolt Down Mounting Base
- Load Monitoring System
- Three Coat Marine Paint System
- Third Party Certification

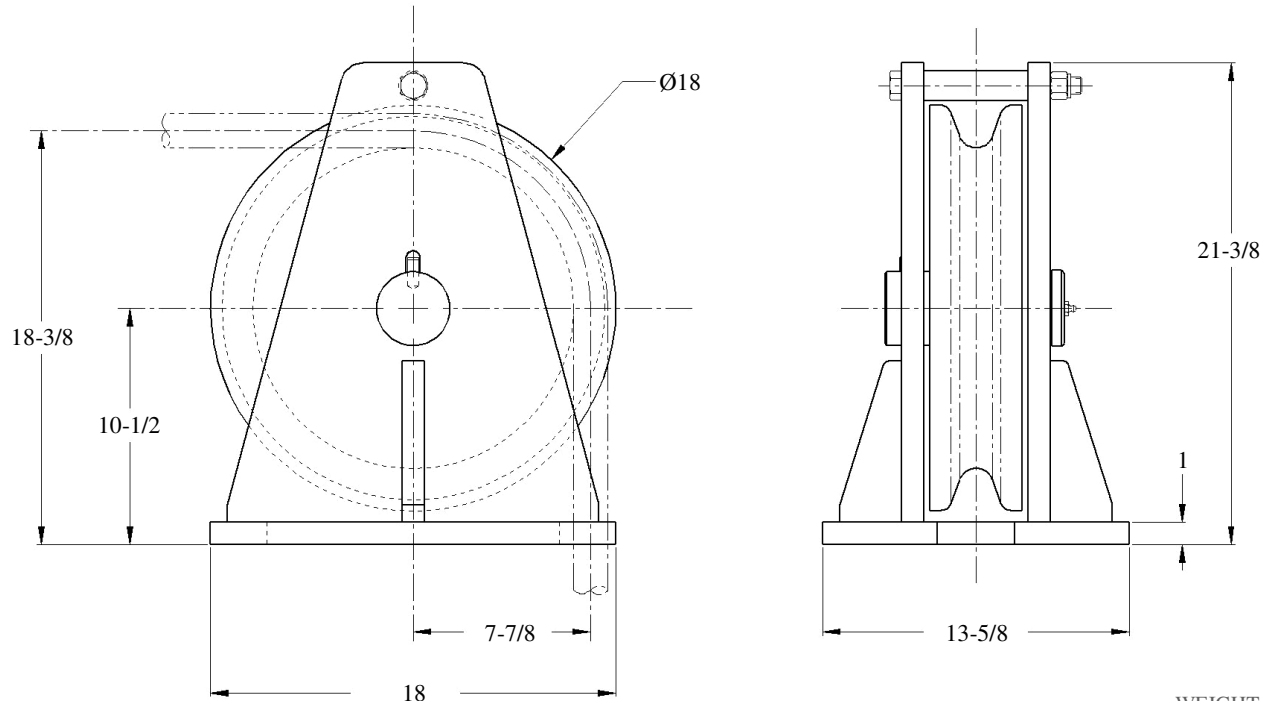

WEIGHT: 340 LBS

* DIMENSIONS SUBJECT TO CHANGE WITHOUT NOTICE*

Rasmussen Equipment Company

415 S. Cloverdale St. Seattle, WA 98108
Tel: 206-762-3700

2220 Engineers Rd Belle Chasse, LA 70037
Tel: 504-392-0442

E-mail: info@RasmussenCo.com Web: www.RasmussenCo.com Toll Free: 800-227-7920